

PHY102 Electricity

Topic 7 (Lectures 10 & 11) – Electric Circuits

In this topic, we will cover:

- 1) Electromotive Force (EMF)
- 2) Series and parallel resistor combinations
- 3) Kirchhoff's rules for circuits
- 4) Time dependence in RC circuits

Reading from Young & Freedman:

For this topic, read sections 25.4 & 25.5, the introduction to chapter 26 and sections 26.1 to 26.2 & 26.4.

Introduction

Charges will always move spontaneously to a position of lower potential energy. (Positive charges move to lower potential, negative charges to a point at more positive electrostatic potential.) A current will therefore not continue to flow in a circuit on its own – some device must be present to raise the charges to a higher potential energy again. We can see the same thing if we consider conservation of energy. Current flowing in a circuit which possesses resistance will dissipate electrical power, and this power must be supplied by some external agency. A third way of expressing this is that in any closed loop or circuit, the potential difference in traversing the circuit and returning to the same point must be zero; since positive charge drops in potential as it flows along a wire, some means must exist to raise it in potential for it to get back to its start point. The device required to complete the circuit is said to be a source of electromotive force (emf), and may be a battery or an electromagnetic generator which convert chemical or mechanical energy respectively into increased electrostatic potential energy.

Electromotive Force

The diagram alongside shows a simple circuit of a battery connected via two wires to a resistor. The arrows show conventional current direction – the direction taken by a hypothetical positive carrier particle. When the carrier enters the negative terminal of the battery, it has its potential raised to a fixed positive value in order to reach the positive terminal. As it moves through the wire and resistor, it falls to a lower potential, its electrostatic energy being converted to thermal energy due to collisions with the lattice. It returns to the negative terminal at the same potential as it started.

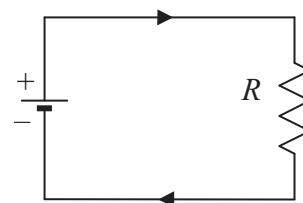

The battery must do work to move charges to the terminals against the repulsion of the charges already present there. In this case, chemical energy is converted into electrical potential energy. The emf of the device \mathcal{E} is defined as the work done per unit charge moved from negative to positive terminal. It has the units of Volt (which, remember, is 1 Joule per Coulomb). It should be clear from the units that the emf is not really a force but the energy per charge, as is potential! For this reason it is common to use the abbreviation emf in preference to the words “electromotive force”.

Internal Resistance and Terminal Voltage

An ideal source of emf would simply raise charges to the required potential. Real devices, such as batteries and generators, also have some internal resistance, r . The terminal voltage, V_T , available to the external circuit, then depends on the current flowing. The potential difference across the internal resistance must be $I r$, so the terminal voltage is

$$V_T = \mathcal{E} - I r. \quad [1]$$

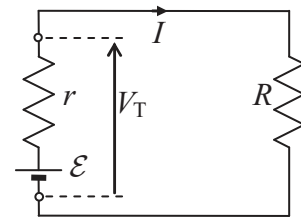

The external voltage is also given by $V_T = I R$. We can further express this as

$$\mathcal{E} = I r + I R \quad [2]$$

So

$$I = \frac{\mathcal{E}}{R + r} \quad [3]$$

Resistors in Series and Parallel

We previously examined circuits with two or more capacitors connected together, and saw that they behaved like a single capacitor, with a capacitance which we could calculate from the individual capacitance values. We will now see that a similar situation exists for combinations of resistors, which can again be expressed as an effective overall resistance.

Resistors in Series

Two resistors in series will have a common current I flowing through them. The voltage across R_1 is given by $V_1 = I R_1$. Similarly $V_2 = I R_2$. The total voltage across the combinations is just $V = V_1 + V_2 = I (R_1 + R_2)$. Defining the overall resistance R

in the usual way,

$$R = \frac{V}{I} = R_1 + R_2.$$

For N resistors in series,

$$\boxed{R = R_1 + R_2 + \dots + R_N}. \quad [4]$$



(In a series combination, the total resistance is always greater than any individual resistance.)

Resistors in Parallel

When two resistors are in parallel, it is the voltage across them which is common, and the current splits to flow through the resistors separately. We

therefore have $I_1 = \frac{V}{R_1}$ and $I_2 = \frac{V}{R_2}$, with the total current I being given by

$I = I_1 + I_2$. Defining the overall resistance R as before as $R = \frac{V}{I}$, we have

$$\frac{1}{R} = \frac{I_1 + I_2}{V} = \frac{1}{R_1} + \frac{1}{R_2}.$$

For N resistors in parallel,

$$\boxed{\frac{1}{R} = \frac{1}{R_1} + \frac{1}{R_2} + \dots + \frac{1}{R_N}}. \quad [5]$$

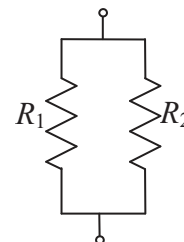

(In a parallel combination, the total resistance is always less than the smallest individual resistance.)

Kirchhoff's Rules

Some circuits are more complicated than series or parallel connections. For these, it can be helpful to use Kirchhoff's junction and loop rules.

Kirchhoff's junction rule is a statement of the conservation of charge. *The algebraic sum of the currents entering and leaving a junction is zero.*

$$\Sigma I = 0. \quad [6]$$

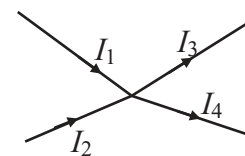

In the figure alongside, this means $I_1 + I_2 - I_3 - I_4 = 0$.

Charge is neither created nor destroyed at the junction, and it does not accumulate there.

Kirchhoff's loop rule is a statement of the conservation of energy. *The algebraic sum of the changes in potential around any closed loop is zero.*

$$\Sigma V = 0. \quad [7]$$

Thus when any charge passes in a closed loop around a circuit, it returns to the same potential. When charge passes from the negative to the positive terminal of a source of emf, its potential is raised. When it passes through a resistance, it falls in potential.

An illustration of the use of Kirchhoff's rules is given in the examples at the end of this topic.

RC Circuits

Circuits containing only components of constant resistance and emf will have a steady current flowing. When a capacitor is included in the circuit, the current is likely to change with time. This is because the voltage across the capacitor depends on the charge it holds, and it takes time for a flowing current to gradually charge or discharge the capacitor. (If a capacitor were connected with *ideal* wires, of zero resistance, to an *ideal* emf, with no internal resistance, then it would be charged instantly.)

Capacitor Discharge

Consider the circuit alongside, consisting of a capacitor and resistor in parallel connected across an ideal battery with emf \mathcal{E} . As long as the switch is closed, the potential difference across both capacitor and resistor is \mathcal{E} , and the charge on the capacitor is $Q_0 = C\mathcal{E}$. The switch is then opened at time $t = 0$. The capacitor then discharges through the resistor, and the current is just the rate of *discharge*,

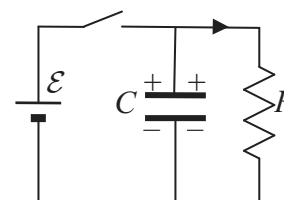

$$I = -\frac{dQ}{dt}. \quad [8]$$

The potential difference, V , is $V = \frac{Q}{C} = IR$.

Using [8], $\frac{Q}{C} = -R \frac{dQ}{dt}$

Rearranging and integrating, we have $-\frac{1}{RC} \int_0^t dt = \int_{Q_0}^Q \frac{dQ}{Q}$

So $\ln\left(\frac{Q}{Q_0}\right) = -\frac{t}{RC}$

or $Q = Q_0 e^{-t/RC}$. [9]

In other words, the charge on the capacitor decays away exponentially. We can also consider how the voltage and current change. Since $V = \frac{Q}{C}$ and $\mathcal{E} = \frac{Q_0}{C}$, [9] also gives us $V = \mathcal{E} e^{-t/RC}$.

If we differentiate [9] with respect to time, we obtain

$$-I = -\frac{Q_0}{RC} e^{-t/RC} \quad \Rightarrow \quad I = \frac{\mathcal{E}}{R} e^{-t/RC} = I_0 e^{-t/RC}$$

Note that all three quantities, charge, voltage and current, die away with the same *time constant* $\tau = RC$. When $t = RC$, the charge (for example) has decayed to $e^{-1} \approx 37\%$ of its initial value. We can also define the *half-life* $T_{1/2}$ of the charge, that is the time required for it to fall to its original value. Equation [8]

then gives us
$$\frac{Q}{Q_0} = \frac{1}{2} = e^{-\frac{T_{1/2}}{RC}}$$

Taking the natural logarithm, this gives

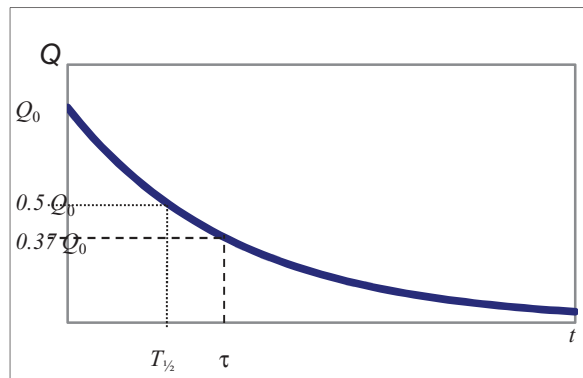

Charging a Capacitor

Now consider the circuit illustrated, where the capacitor and resistor are in series. Initially the capacitor is uncharged, then the switch is closed at time $t = 0$. We can employ the loop rule [7], passing clockwise round the circuit, to obtain

$$\mathcal{E} - IR - \frac{Q}{C} = 0.$$

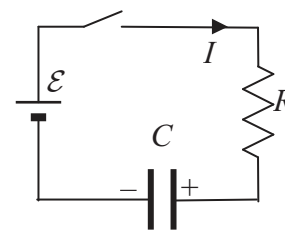

(Remember that the potential falls as we follow the current through the resistor or capacitor.) The same result can also be obtained by considering that the sum of the potential differences across the resistor and the capacitor must add up to the emf from the battery. The current now is *charging* the capacitor, so we have

$$I = \frac{dQ}{dt}.$$

Therefore

$$\frac{dQ}{dt} R = \mathcal{E} - \frac{Q}{C} = \frac{C\mathcal{E} - Q}{C} = \frac{Q_0 - Q}{C}.$$

Here we are defining $Q_0 = \mathcal{E}C$ as the final, fully charged value for the charge on C .

$$\begin{aligned} \frac{1}{RC} \int_0^t dt &= \int_0^Q \frac{dQ}{Q_0 - Q} \\ \frac{t}{RC} &= [-\ln(Q_0 - Q)]_0^Q \\ -\frac{t}{CR} &= \ln\left(\frac{Q_0 - Q}{Q_0}\right) \end{aligned}$$

\Rightarrow

$$1 - \frac{Q}{Q_0} = e^{-t/RC}$$

$$\boxed{Q = Q_0 \left(1 - e^{-t/RC}\right)} \quad [10]$$

We see that we have the same time constant, $\tau = RC$, but in this case this gives the time required for the current to rise to 63% of its final value. Once again, we can also examine the voltage across the capacitor:

$$V = \frac{Q}{C} = \frac{Q_0}{C} \left(1 - e^{-t/RC}\right) = \mathcal{E} \left(1 - e^{-t/RC}\right).$$

And finally the current (through either resistor or capacitor) is given by

$$I = \frac{dQ}{dt} = \frac{Q_0}{RC} e^{-t/RC} = \frac{\mathcal{E}}{R} e^{-t/RC} = I_0 e^{-t/RC}.$$

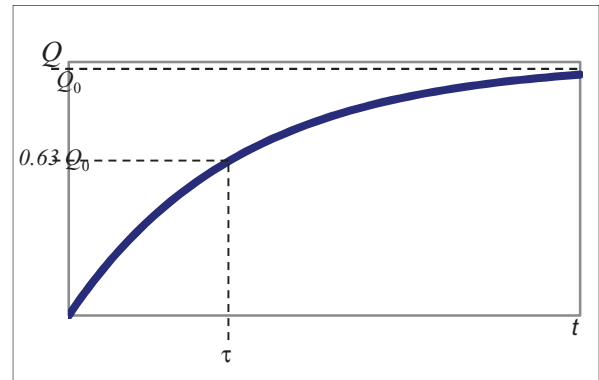

Note that here I_0 is the *initial current*, and that the functional form is the same as it was for the case of *discharging* the capacitor.

Putting What You Have Learnt Into Practice

Question 7.1

A battery has an emf of 1.60 V and an internal resistance of 0.15Ω. It is connected to a load resistance of 3.0Ω.

(a) What is the terminal voltage of the battery?

(b) How much power is (i) delivered to the load resistor; (ii) dissipated inside the battery; (iii) produced in total by the battery?

Solution

(a) The terminal voltage depends on the current, so we first work that out.

$$I = \frac{\mathcal{E}}{R+r} = \frac{1.60}{3.15} = 0.508 \text{ A} .$$

$$V = \mathcal{E} - Ir = 1.60 - 0.508 \times 0.15 = 1.52 \text{ V} .$$

(b) (i) The external power is $P_{\text{ext}} = I^2 R = 0.508^2 \times 3.0 = 0.774 \text{ W} = 774 \text{ mW} .$

(ii) The internal power is $P_{\text{int}} = I^2 r = 0.508^2 \times 0.15 = 39 \text{ mW} .$

(iii) The total power is $P_{\text{tot}} = \mathcal{E}I = 1.60 \times 0.508 = 813 \text{ mW} ,$

which is the sum of the answers to parts (i) and (ii), as it should be!

Question 7.2

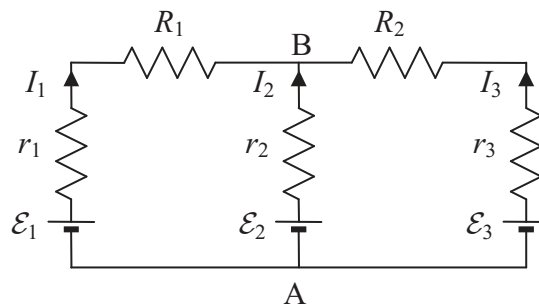

The circuit above consists of 3 different imperfect batteries connected to two equal resistors. Find the currents I_1 , I_2 and I_3 leaving the batteries, and the potential difference from A to B, V_{AB} .

Take $\mathcal{E}_1 = 6 \text{ V}$, $r_1 = 1\Omega$, $\mathcal{E}_2 = 10 \text{ V}$, $r_2 = 2\Omega$, $\mathcal{E}_3 = 12 \text{ V}$, $r_3 = 3\Omega$ and $R_1 = R_2 = 20\Omega$.

Solution

Applying Kirchhoff's junction rule at B,

$$I_1 + I_2 + I_3 = 0 \quad \Rightarrow \quad I_3 = -I_1 - I_2 \quad (1)$$

(Note that the currents I_1 , I_2 , I_3 cannot all be flowing in the directions indicated towards point B. We do not know which flow in the other direction, but this will become apparent from the calculated values being negative.)

Applying Kirchhoff's loop rule for the left hand circuit, in clockwise direction,

$$\mathcal{E}_1 - I_1 r_1 - I_1 R_1 + I_2 r_2 - \mathcal{E}_2 = 0$$

\Rightarrow

$$\mathcal{E}_1 - I_1 (r_1 + R_1) + I_2 r_2 - \mathcal{E}_2 = 0 \quad (2)$$

Applying Kirchhoff's loop rule for the right hand circuit, in clockwise direction,

$$\mathcal{E}_2 - I_2 r_2 + I_3 R_2 + I_3 r_3 - \mathcal{E}_3 = 0 \quad (3)$$

Substitute (1) in (3) \Rightarrow

$$\mathcal{E}_2 - I_2 r_2 - (I_1 + I_2)(R_2 + r_3) - \mathcal{E}_3 = 0$$

\Rightarrow

$$\mathcal{E}_2 - I_1 (R_2 + r_3) - I_2 (r_2 + R_2 + r_3) - \mathcal{E}_3 = 0 \quad (4)$$

Now substitute in the component values given to give simultaneous equations we can solve:

$$(2) \Rightarrow \begin{aligned} 6 - I_1 \times 21 + I_2 \times 2 - 10 &= 0 \\ -21I_1 + 2I_2 &= 4 \end{aligned} \quad (5)$$

$$(4) \Rightarrow \begin{aligned} 10 - I_1 \times 23 + I_2 \times 25 - 12 &= 0 \\ -23I_1 - 25I_2 &= 2 \end{aligned} \quad (6)$$

$$25 \times (5) + 2 \times (6) \Rightarrow \begin{aligned} (-525 - 46)I_1 &= 100 + 4 \\ I_1 &= -0.182 \text{ A} \end{aligned}$$

$$\text{Substitute in (5)} \quad I_2 = \frac{4 + 21 \times (-0.182)}{2} = 0.089 \text{ A}$$

$$\begin{aligned} \text{Substitute in (1)} \quad I_3 &= -I_1 - I_2 = 0.093 \text{ A} \\ V_B - V_B &= \mathcal{E}_2 - I_2 r_2 = 10 - 0.089 \times 2 = 9.82 \text{ V} . \end{aligned}$$

Question 7.3

The circuit alongside shows a $100 \mu\text{F}$ capacitor connected in parallel with a 150Ω resistor and a 3.0 V battery. The switch, which was initially closed, is opened at time $t = 0$. What is the current flowing through the resistor immediately after the switch is opened? After how long will the current have dropped to 1% of this value? What is the energy dissipated in the resistor during the complete discharge?

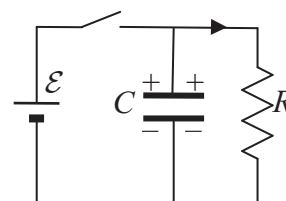

Solution

Initially, the voltage across both capacitor and resistor is \mathcal{E} , so the current is

$$I_0 = \frac{\mathcal{E}}{R} = \frac{3.0}{150} = 0.02 \text{ A} .$$

The current dies away according to

$$I = I_0 e^{-t/CR} .$$

If $\frac{I}{I_0} = 0.01$, then

$$-\frac{t}{CR} = \ln 0.01$$

$$\frac{t}{CR} = \ln 100$$

$$t = CR \ln 100 = 100 \times 10^{-6} \times 150 \times \ln 100 = 0.69 \text{ s} .$$

It takes 0.69 s for the current to decay to 1% of its initial value.

The answer to the final part of the question must just be that the energy stored on the capacitor is dissipated in the resistor, i.e. $U = \frac{1}{2} C \mathcal{E}^2$. However, we can demonstrate this by integrating the instantaneous power.

We have $P = I^2 R$, and $I = I_0 e^{-t/RC} = \frac{\mathcal{E}}{R} e^{-t/RC}$

$$\begin{aligned} U &= \int_0^{\infty} P dt = \left(\frac{\mathcal{E}}{R} \right)^2 R \int_0^{\infty} e^{-2t/CR} dt \\ &= \frac{\mathcal{E}^2}{R} \left[-\frac{CR}{2} e^{-2t/CR} \right]_0^{\infty} \\ &= \frac{\mathcal{E}^2}{R} \frac{CR}{2} = \frac{\mathcal{E}^2 C}{2} = \frac{3^2 \times 100 \times 10^{-6}}{2} = 4.5 \times 10^{-4} \text{ J} \end{aligned}$$

The total energy dissipated in the resistor is 0.45 mJ.

Problems from Young & Freedman for Topic 7:

Try to do exercises 25.28 to 25.38, 25.46 to 25.53, 25.61 to 25.84, 26.1 to 26.34, 26.40 to 26.51 and 26.55 to 26.78. The later problems in each chapter are more challenging. (Numerical answers to odd-numbered questions are available at the back of the book.)